



Technical Notes Volume 1, Number 30

Cone Midrange Compression Drivers (CMCD)

Introduction:

Throughout the history of professional audio it has been realized there are distinct performance advantages to compression and horn-loading a midrange transducer. The advantages include increased sensitivity and bandwidth, desirable pattern control, and arrayability - all provided by horn-loading. Other advantages include reduced harmonic and inter-modulation distortion, and increased maximum SPL.

Unfortunately, these theoretical benefits have been difficult to simultaneously achieve in practice, due to the lack of transducers that are suited to this application, but also due to compromises in the design of the horn and/or phasing plug.

Because of these limitations, many previous solutions have suffered from poor frequency response, restricted high frequency bandwidth, and non-ideal area expansions that introduce other anomalies. These limitations, and others, contribute to audible irregularities often referred to as a "horn midrange sound".

This technical note will discuss how these limitations were overcome in the family of JBL Cone Midrange Compression Drivers (CMCD's). Pertinent performance figures are presented in comparison and in contrast to other past and present solutions. Finally, typical CMCD performance characteristics are provided.

Historical and Technical Background:

The design of horn-loaded midrange systems can broadly be categorized into two philosophies: The first is based on high-frequency compression driver designs that are optimized to operate over a lower frequency range. The second approach uses a cone midrange loaded directly by the horn, or coupled to the horn with a phase plug.

Solutions derived from a high frequency compression driver may have numerous problems, including high harmonic distortion (due to high compression ratios, and limited excursion capability), and limited low frequency extension (due to improper Theil-Small parameters for this application). These designs may break under high output, or inadvertent abuse. They require a very large horn in order to operate optimally.

The second solution — a cone midrange driver coupled to a horn can correct most of the problems of a compression horn-loaded midrange system. However, other limitations are often introduced.

One of these limitations in the past has been limited high-frequency extension. Even an ideal cone transducer has a mass break point of approximately 600 Hz to 900 Hz which limits high frequency extension. While many manufacturers attempt to correct this with various phase plug designs, the limitation still exists — the moving

mass is too high, and the motor force provided by the magnet structure limits sensitivity. As well, many phase plug and displacement plug designs do not provide the uniform compression of the wavefront required to produce extended and smooth frequency response.

After evaluating the state-of-the-art, JBL engineers developed a new family of midrange devices that eliminate performance limitations, and maximize sound quality. The resulting midrange components are referred to as a Cone Midrange Compression Driver (CMCD). These proprietary JBL implementations are patent-pending.

CMCD models are based around industry accepted, and proven, high-output JBL midrange transducers such as the 2250, used in VERTEC™ VT4889 line-array systems, and the 165H, used in Cinema ScreenArray® systems. These transducers meet and achieve the requirements for optimal performance in a CMCD configuration.

Key Performance Features:

CMCD models include the CMCD-81J, CMCD-81H, and the CMCD-61H. Each CMCD assembly incorporates a JBL cone midrange driver, a 3 slot annular-ring phasing plug, and a thermally conductive rear chamber. An optimal 4-inch exit-diameter and a correct exponential expansion provide excellent coupling to the entire family of Progressive Transition™ midrange waveguides. Section-

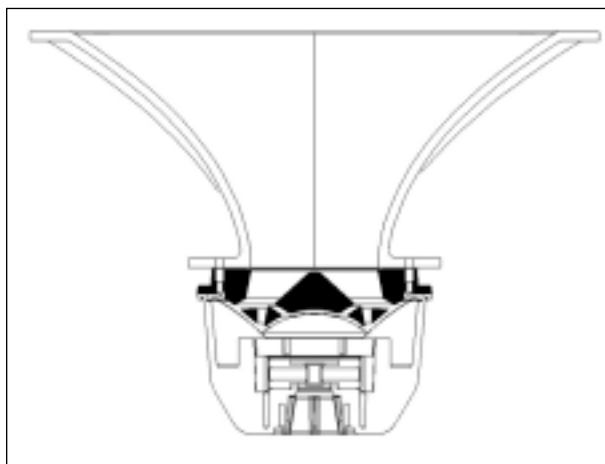

Figure 1: Section View of CMCD-81H and PT Midrange Waveguide.

views of the CMCD-81H/J, and CMCD61H, coupled to a PT waveguide, are shown in Figures 1 and 2.

CMCD-81 models have a recommended bandwidth of 250 Hz to 2.0 kHz, and power handling of 350 watts. Sensitivity is 107 dB SPL/1w/1m on a typical 90°x50° waveguide. Frequency response and electrical impedance are shown in Figure 3. Due to pistonic response within the pass-band, response deviations of less than ± 0.5 dB result with simple equalization. Maximum continuous SPL exceeds 133 dB SPL at 1 meter on appropriate waveguides.

The CMCD-61H recommended bandwidth is 400 Hz to 3.5 kHz. Power handling is 125 watts. Sensitivity at 1 watt/1 meter is 107 dB SPL on a typical 90°x50° waveguide. Frequency response and electrical impedance are shown in Figure 4. Due to pistonic behavior throughout the pass-band, response variations of ± 0.5 dB are realized with simple EQ. Maximum SPL exceeds 128 dB at 1 meter.

The CMCD-81 is ideally suited for applications that call for maximum output, or where a lower cross-over to the low-frequency section is required.

The CMCD-61 is suited to applications where extreme SPL is not required. In installations where cost is critical but pattern control, low distortion, and excellent midrange clarity are still required, systems incorporating a CMCD-61H are an ideal solution.

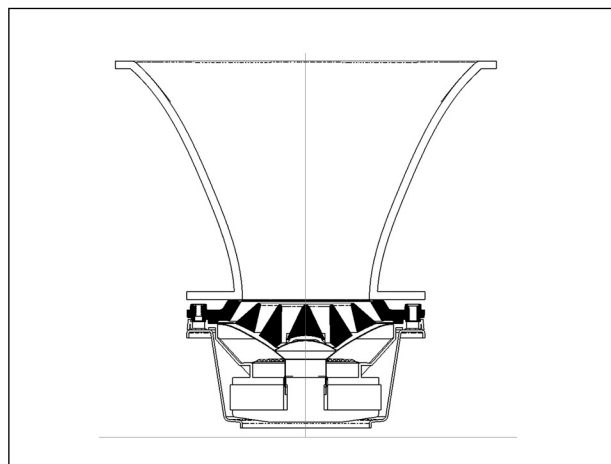

Figure 2: Section View of CMCD-61H and PT Midrange Waveguide.

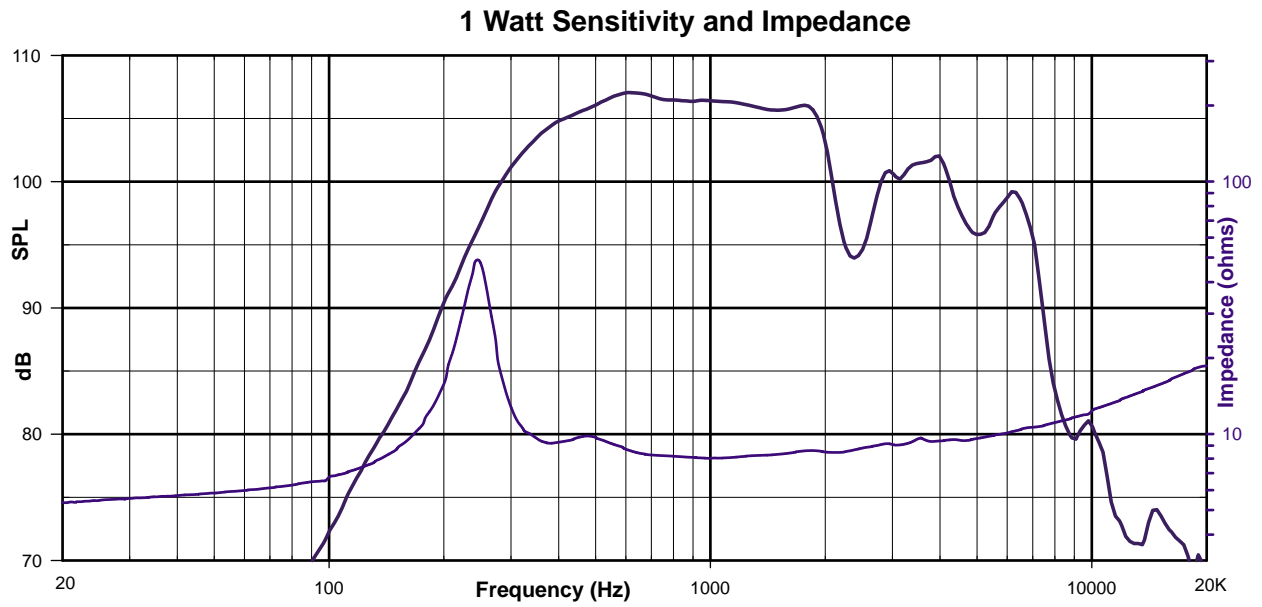

Figure 3: Frequency Response and Impedance of CMCD-81H with 90° x 50° PT Waveguide.

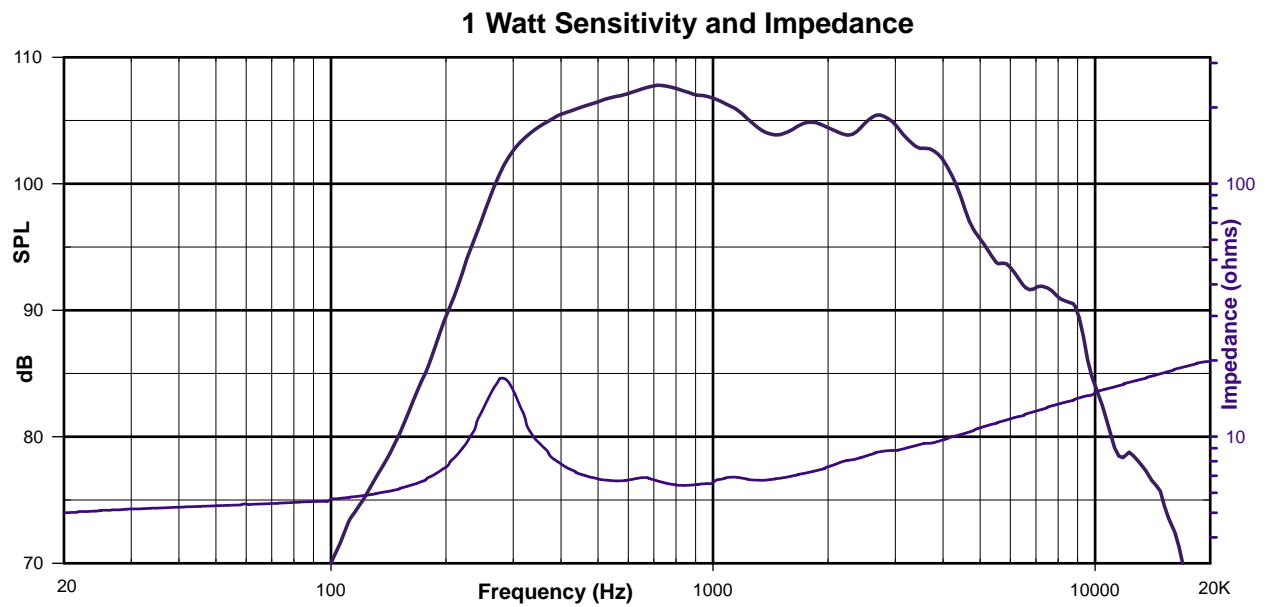

Figure 4: Frequency Response and Impedance of CMCD-61H with 90° x 50° PT Waveguide.

Technical Details:

CMCD assemblies use 8-inch and 6.5-inch cone midrange drivers designed from the ground-up to operate as true compression loaded midrange devices. The phasing plugs, and optimal rear chambers, provide maximum sensitivity and wide bandwidth.

Design features for improved performance include: Small diameter midrange cone drivers, thermally conductive rear enclosures, and annular ring phase plugs with 4-inch exit diameters. The benefit of each feature is elaborated on in the following sections:

True Annular Ring Phasing Plug:

CMCD designs feature a three-slot annular-ring phasing plug to provide optimal loading of the cone diaphragm to frequencies as high as 3.5 kHz — in the case of the CMCD-61H.

CMCD assemblies employ phasing-plugs die-cast in a high-density polyester-fiberglass thermoset-composite. The phase plugs are rigidly-bounded three-piece annular designs. This construction allows for close dimensional tolerances in production, and eliminates variability. CMCD phase plugs are typically spaced 0.075 inches from the cone.

Many solutions have incorporated either one-piece displacement plugs, or molded polystyrene foam phase plugs. In either case the results are not optimal due to acoustical losses in the phase plug, and excessive spacing from the speaker cone. Sensitivity and high frequency extension are compromised.

The low-loss composite structure of CMCD phase plugs increases sensitivity by more than 2 dB, as compared to a phase plug fabricated in expanded polystyrene.

An Optimal Exit Diameter:

Each CMCD features a 4-inch exit diameter to couple to a Progressive Transition (PT) midrange waveguide. The 4 inch exit provides two key advantages:

First, compared to a 2-inch or 3-inch exit, the 4-inch exit produces significantly lower air pressure

at the throat. This lowers harmonic and intermodulation distortion dramatically. The distortion performance of each CMCD equals systems where the transducer couples directly to the waveguide throat.

Secondly, the 4-inch exit allows for waveguide coverage angles of up to 130° with a crossover points as high as 2-3kHz. Solutions with larger throat diameters have difficulty achieving 90° coverage with a 1 kHz crossover-point, in comparison.

Smaller Cone Diameter Transducers for Extended Bandwidth and High Sensitivity:

Why did JBL choose to use smaller 8-inch and 6.5-inch transducers? The answer is that in a compression & waveguide loaded midrange system, the diameter of the cone does not matter! With proper loading provided by an annular-ring phase plug, cone excursion is always extremely low. The two parameters that determine sensitivity and bandwidth are moving mass and magnetic circuit strength.

To provide wide bandwidth and high sensitivity, moving mass must be minimized, and motor strength must be maximized. Larger diameter drivers may provide high motor strength, but a larger cone diameter fundamentally limits how low the moving mass can be.

The midrange transducers at present are the 8-inch diameter 2250 and the 6.5-inch diameter 165H. The 2250 feature JBL's patented Neodymium Differential Drive® (NDD™) technology, providing 350 watt power handling and half the power compression of traditional designs. The 165H is an established high motor strength ceramic magnet design, featuring 125 watt power handling and an extremely low moving mass for extended high frequency bandwidth.

As noted, the two parameters that dominate in determining sensitivity and usable bandwidth are “motor strength”, or $(B \cdot L)^2 / R_e$, and “moving mass”, M_{ms} . Examining the industry standard 12-inch diameter JBL 2012, the 2250 has a higher $(B \cdot L)^2 / R_e$ of 58.2 ohm compared to 41.5 ohm for the 2012. The moving masses of the two transducers are equal at 25 grams. Considering the higher motor strength, and equal moving mass, we see

the 2250 is actually a higher sensitivity transducer, when the waveguide provides a sufficient acoustic impedance load. A similar analysis shows the 165H provides the same advantages over other industry comparable transducers.

For comparison Figure 5 shows cut-away views of the 2012 and the 2250.

JBL 2012:

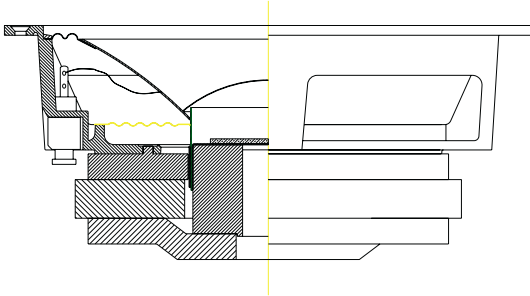

JBL 2250:

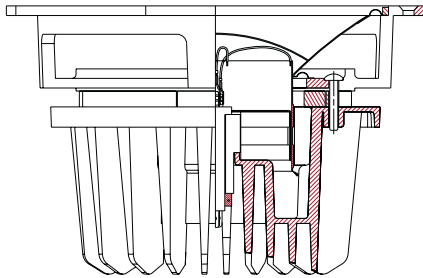

Figure 5: JBL 2012H, Traditional 12-inch High-Output Midrange driver.

Optimal Sized Thermal Conductive Rear Enclosures:

Existing cone midrange horn-loaded systems often incorporate a large rear chamber typically filled with lossy damping material such as fiberglass or polyester wool. However, when a midrange device is loaded by a properly designed annular ring phase plug and an appropriate midrange waveguide such a solution is not sufficient.

To extend bandwidth to a lower frequency, the rear chamber must be sized for proper reactance nulling — The acoustical air load (acoustic mass) provided by the waveguide and phasing plug must be

cancelled by the acoustic stiffness (acoustic compliance) of the rear enclosure of the midrange. Plach (Design Factors in Horn Type Speakers, JAES, October, 1953) shows that the rear enclosure then needs to be very small. Any lossy absorption in the rear enclosure reduces output in the lower frequency range. An optimally sized rear enclosure can be acoustically shaped to eliminate resonances within the enclosure, without using lossy damping materials. The result is ideal lower frequency bandwidth and resonance-free response.

The rear chambers are thermally conductive aluminum enclosures to allow heat from the motor structure to dissipate. This reduces power compression and increases power handling. This JBL proprietary technology was first employed in JBL's Venue Series®. Other proven applications include JBL LSR Studio Monitors, VerTec VT4889, and PD™ Precision Directivity Systems.

CMCD rear chambers seal against the rear of the transducer frame, allowing heat to escape freely. In the CMCD-81, the entire NDD motor structure — with its cooling fins — is outside of the rear enclosure. In the CMCD-61, the entire backplate of the ceramic magnet structure is exposed to the surrounding air for better thermal performance.

CMCD Advanced Technical Features:

- Correct spacing from the cone provides correct acoustic coupling. The result is optimal low volume velocity and high pressure at the cone.
- Uniform cone loading provided by CMCD phasing plugs ensures pistonic response, and extended bandwidth.
- A flat wavefront at the waveguide throat results from path length compensation. This ensures smooth and predictable on and off-axis response, and increased signal coherency.
- Optimal low frequency loading results in increased LF bandwidth.
- Optimal cone/phase-plug spacing provides maximum mid-band sensitivity.
- Optimal slot gap-width, and slot location extends HF bandwidth by moving transverse

resonances between the cone and phase plug to a much higher frequency.

- A Moderate 7:1 compression ratio provides low distortion performance, equaling that of designs such as JBL ScreenArray and PD systems that do not use phasing plugs.
- A 3 to 5 dB increase in sensitivity results, compared to systems that couple the transducer directly to the waveguide throat, without a phasing plug.
- A 4-inch exit diameter provides low distortion performance, and allows extremely wide coverage angle horns to be designed.

Technical and Subjective Performance:

This section documents the performance of each CMCD, and compares the performance to existing solutions. The technical performance presented provides an examination of objective and subjective performance features of CMCD designs.

Plane-Wave Tube Response:

Figure 6 shows acoustical power-response of a CMCD-81H, mounted to a 4-inch diameter plane-wave tube, 16 feet in length, as shown in Figure 7. Measuring the acoustic response of a compression driver on a plane-wave tube is equivalent to measuring the near-field response of a direct radiating transducer. The plane-wave tube isolates the response of the compression driver from the effects of a waveguide. Response anomalies seen on the plane-wave tube will likely show in the on- and off-axis curves of the compression driver on a waveguide, and will likely be audible.

Referring to Figure 6, note the high 30% efficiency of the CMCD-81H in converting electrical power to acoustical power. As well, note the smooth frequency response through the entire usable range from 200 Hz to 2000 Hz. Coupled to a correct waveguide, we expect uniform frequency response, high sensitivity, and an uncolored sound quality.

Figure 8 shows the plane-wave tube response of the CMCD-61H. 34% efficiency is achieved, and the acoustical response is free of resonances. Usable bandwidth extends from 350 Hz to 3.5 kHz.

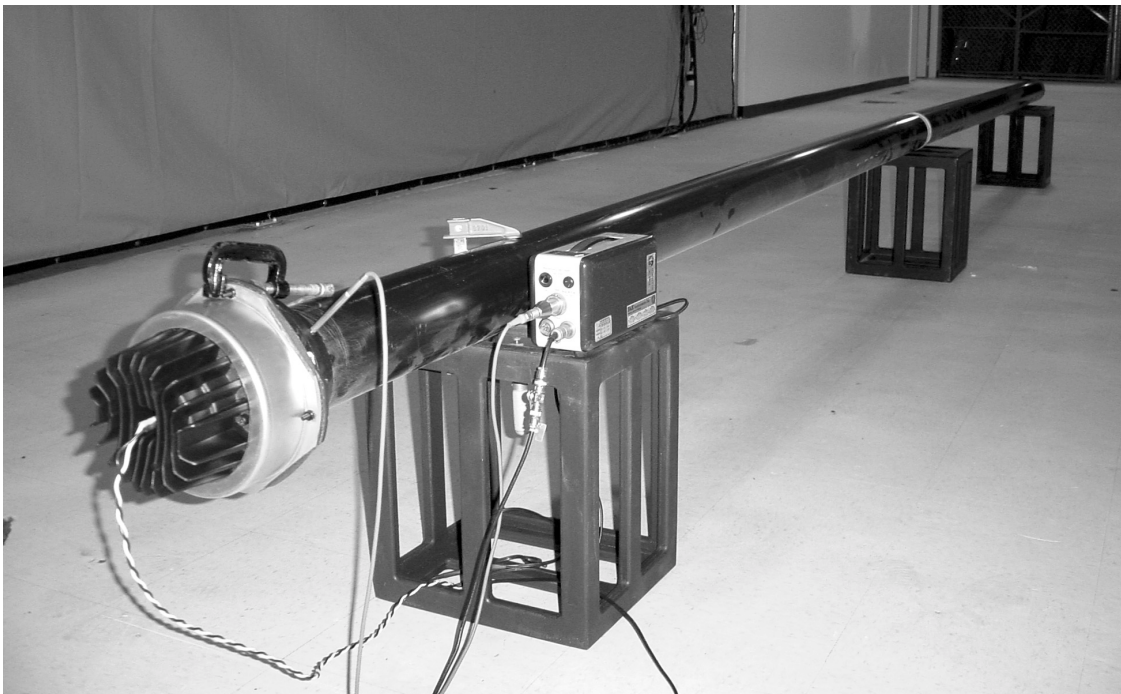

Figure 7: Photograph of 4.9 meter (16 foot) 4-inch diameter Plane-Wave Tube with CMCD-81.

Plane-Wave Tube - SPL and Efficiency

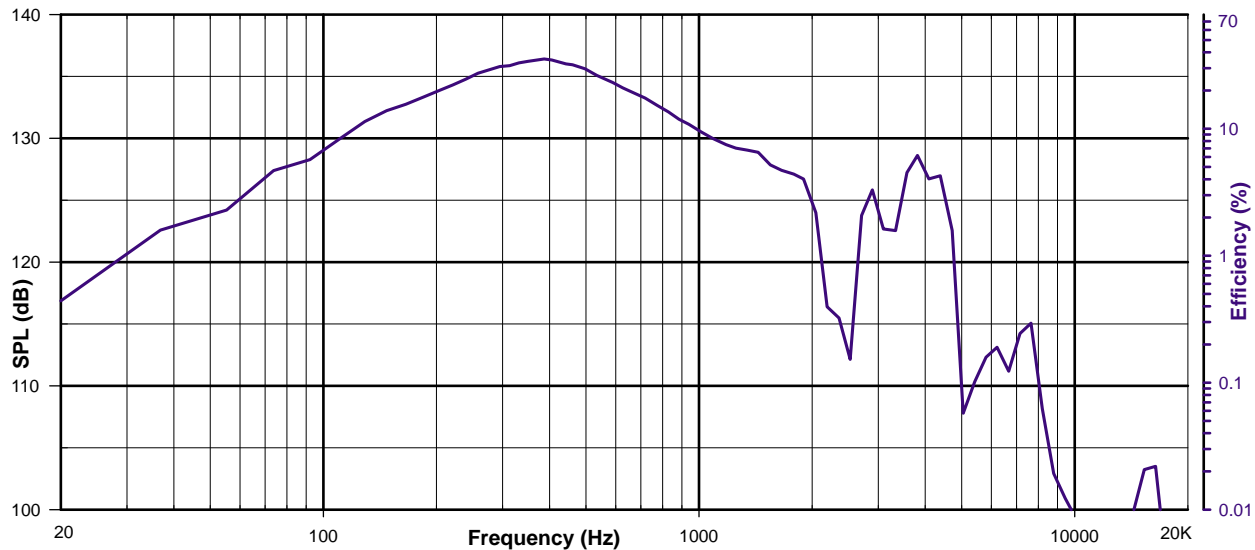

Figure 6: CMCD-81H Frequency Response, Measured on 4-inch Plain-Wave Tube at 1 Watt (2.83 Volts).

Plane-Wave Tube - SPL and Efficiency

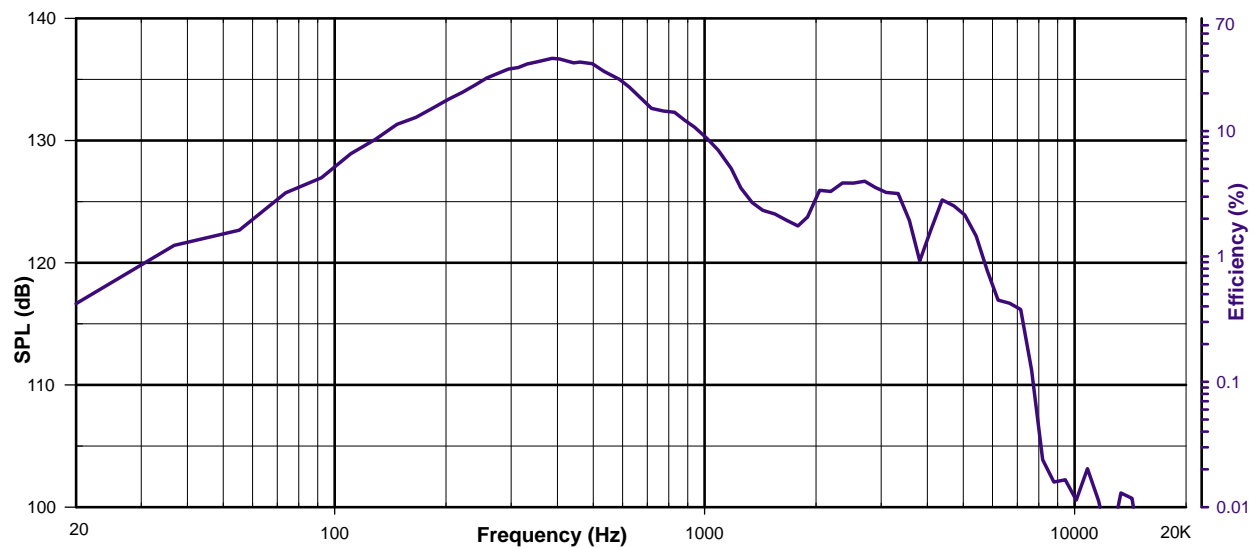

Figure 8: CMCD-61H Frequency Response, Measured on 4-inch Plain-Wave Tube at 1 Watt (2.83 Volts).

Non-Linear Distortion:

High distortion is one of the primary objections of midrange compression drivers. To solve this problem CMCD systems have moderate 7:1 compression ratios and rapid flare rates. The result is a CMCD system does not add additional distortion to the audio signal.

Figure 9 and Figure 10 compare frequency response and harmonic distortion of CMCD-81J's versus JBL 2250J's. The 2250J's radiate directly into the waveguide throat, and the CMCD-81J's are coupled by their phase plug to the waveguide.

A large format JBL ScreenArray dual-midrange waveguide was utilized. The waveguide, model

Frequency Response and Harmonic Distortion

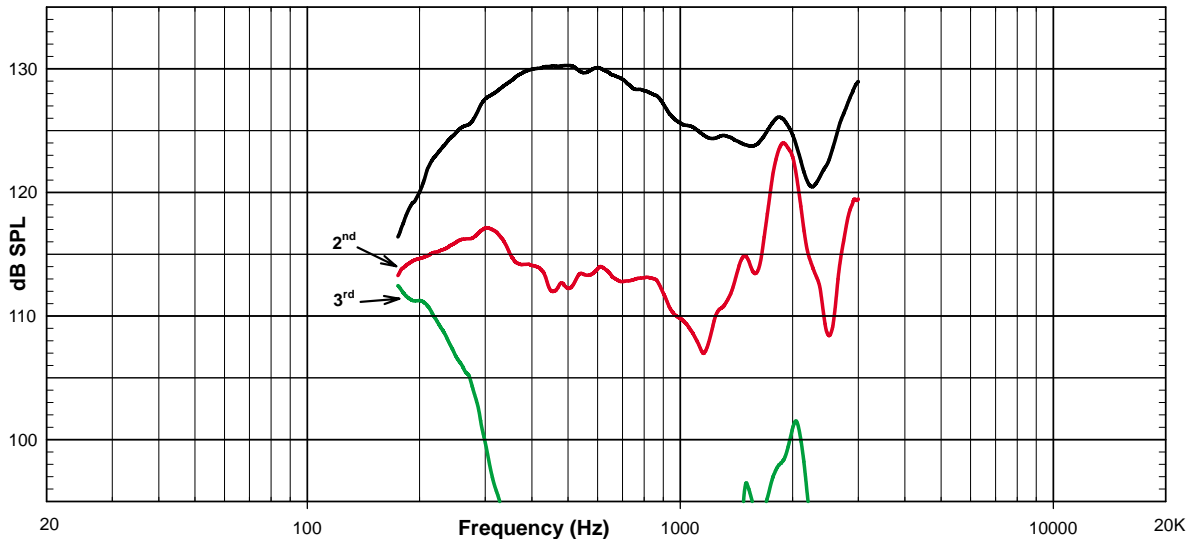

Figure 9: Frequency response and Harmonic Distortion of 2 x 2250J on Large Midrange Waveguide – Drivers are Coupled Directly to Waveguide. Drive Level adjusted for 130 dB SPL/1m at 500 Hz.

Black: Fundamental
 Red: 2nd (raised 20 dB)
 Green: 3rd (raised 20 dB)

Frequency Response and Harmonic Distortion

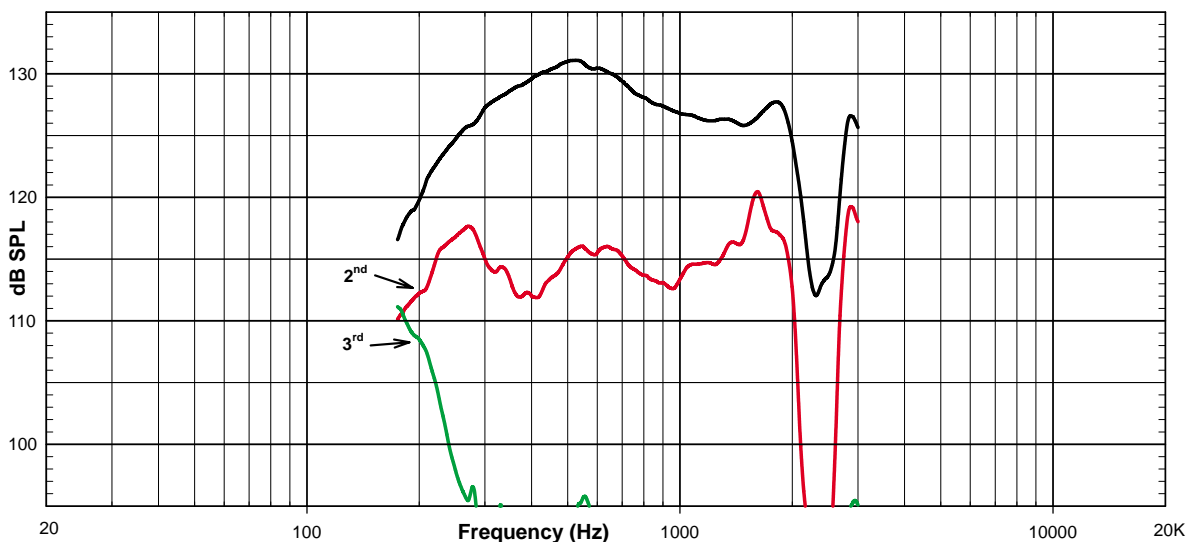

Figure 10: Frequency Response and Harmonic Distortion of 2 x CMCD-81H on same Waveguide coupled with CMCD phase plugs. Drive Level adjusted for 130dB SPL/1m at 500 Hz.

Black: Fundamental
 Red: 2nd (raised 20 dB)
 Green: 3rd (raised 20 dB)

3632-MF, features a rapid flare, a 5.5-inch aperture, and very low intrinsic distortion. To couple the 4-inch exit diameter CMCD-81J to this waveguide, a pair of 4 to 5.5-inch conical transition tubes, 6 inches in length were used.

For this comparison, sound pressure levels were matched. Drive voltages were adjusted to produce 130 dB SPL at 1 meter at 500 Hz. To achieve 130 dB SPL, the non-CMCD system required 163 watts, whereas the CMCD system needed only 84 watts. Therefore the CMCD system is 3 dB more efficient.

Note at 130 dB SPL the level of 2nd harmonic distortion is almost identical, at roughly 0.4%, and in both cases the 3rd harmonic is unmeasurable.

This result shows that CMCD systems add no additional distortion to the signal when compared to a “direct coupled” solution — despite a 3 dB increase in efficiency!

Performance on Large Format Horns:

This section compares frequency response, impedance and maximum SPL of a JBL 2490H to a CMCD-81H. The 2490H is a 3-inch exit-diameter midrange compression driver. The CMCD-81H has a 4-inch exit diameter. A JBL 2393 large format midrange horn was used for the comparison. To measure the CMCD-81H, a modified throat section with a 4-inch entrance was prepared for the 2393.

Figure 11 shows frequency response and electrical impedance for the CMCD-81H and the 2490H. Compared to the 2490H, the CMCD extends lower in frequency by roughly 100 Hz, but above 600 Hz, the CMCD is noticeably less sensitive. However this is only half of the result, as we’ll quickly see.

Figure 12 shows maximum SPL based on rated power handling. We see the 350 watt CMCD-81 matches the 100 watt 2490H to within 1 dB from

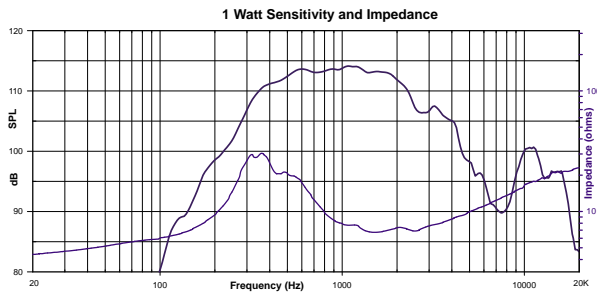

Figure 11a: Frequency Response and Impedance of JBL 2490H on JBL 2393 Horn.

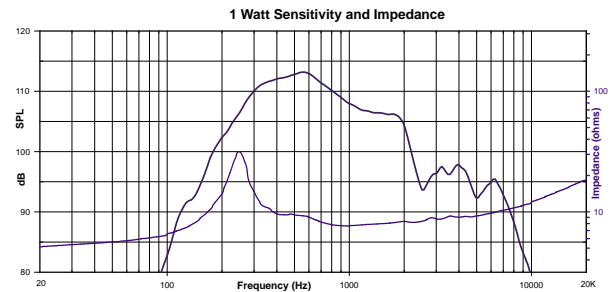

Figure 11b: Frequency Response and Impedance of CMCD-81H on 2393 Horn Using a 4-inch Diameter Throat.

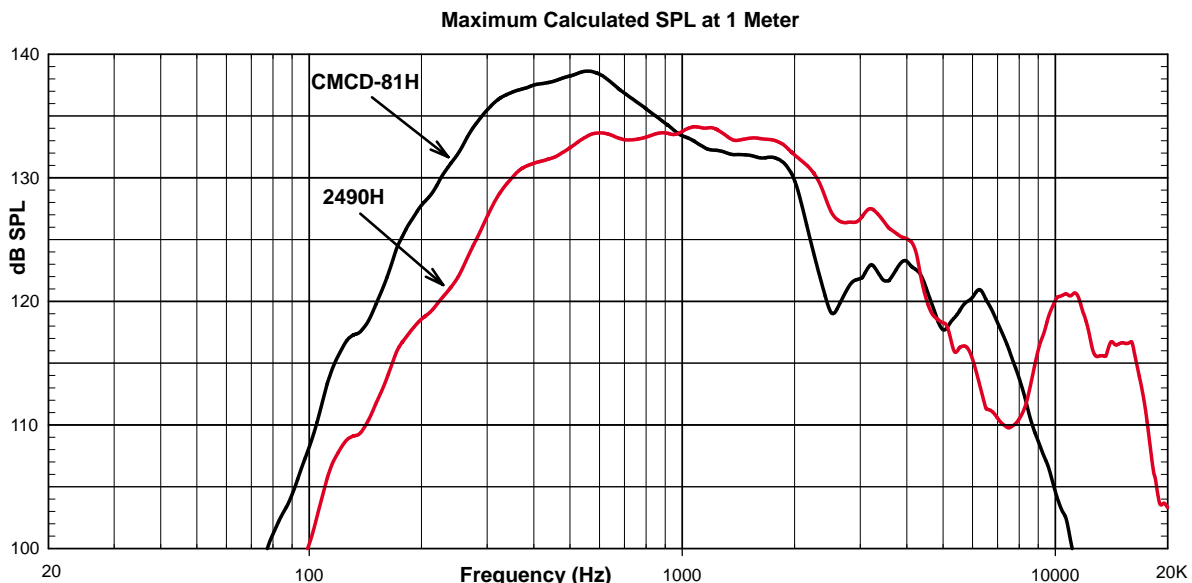

Figure 12: Comparison of Calculated Maximum SPL at 1 meter for 2490H and the CMCD-81H on a 2393 horn.

900 Hz to 2 kHz. However, below 500 Hz, 6 to 8 dB greater output is achieved. Since CMCD-81 distortion is extremely low, this provides more usable output at lower frequencies, and equal output up to the high frequency crossover.

Many applications today require a lower mid-bass/low-frequency cross-over point, and also require increased output from the mid system at its lower range. Based on the data, the CMCD-81 is the leader in this area of performance.

Coherent Time Response:

CMCD assemblies also excel in time-domain response. To examine this subject, Figures 13 and 14 are presented. Figure 13 is a spectral decay plot (or waterfall plot). Figure 14 is an impulse response plot.

For these measurements a CMCD-81H and a 90° x 50° PT waveguide are used. To address the real-world application of this waveguide, 18 dB/Octave Butterworth crossover filters were applied 250 Hz and 2 kHz.

As seen in Figure 13, the impulse response is free of ringing and decays by 20 dB within the first 2 ms. This shows the majority of the acoustic energy

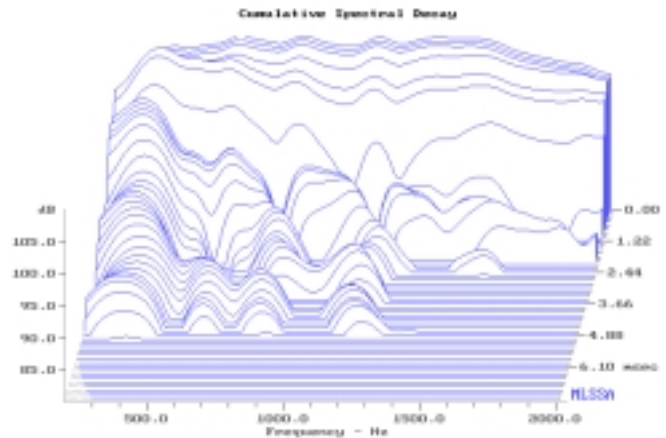

Figure 14: Spectral Decay plot for CMCD-81H on 90° x 50° PT waveguide.

generated by the CMCD midrange arrives early, and additional ringing is minimized. Subjectively this indicates excellent midrange clarity and a lack of “time smear.”

Figure 14 shows the spectral decay of the CMCD is very quick. Additionally the decay shows no unusual frequency dependent resonances.

In all, CMCD solutions provide excellent midrange time-coherency and a freedom from resonances. This results in improved intelligibility, coherent midrange “impact”, and an overall accuracy of reproduction.

JBL Professional - Impulse Response

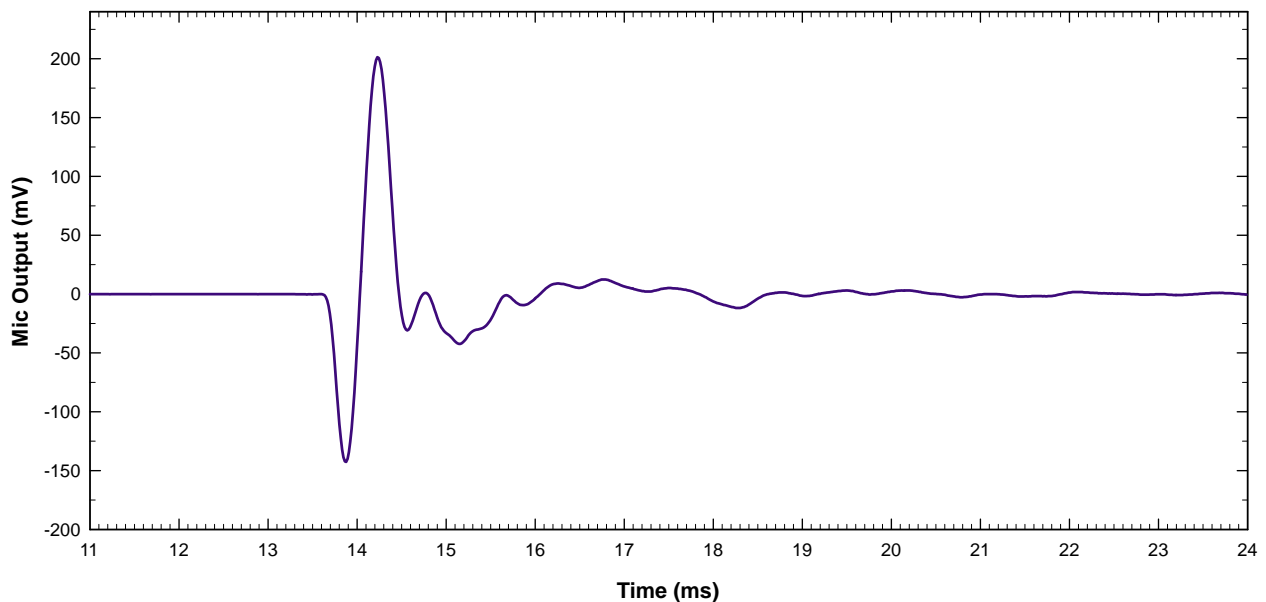

Figure 13: Impulse Response of CMCD-81H on 90° x 50° PT waveguide.

Technical Summary:

It has been shown that CMCD's achieve:

- Resonance free power response, for better sound quality on a wide variety of PT waveguides.
- Distortion performance equivalent to a direct radiating solution.
- Improved bandwidth and higher output levels with lower distortion on large format horns.
- Finally, CMCD solutions provide excellent time response for midrange coherency, accuracy, and intelligibility.

Conclusion:

Each JBL Professional CMCD device incorporates a cone midrange transducer, an optimally sized thermally conductive rear chamber, and an annular ring phasing plug for optimal performance.

CMCD systems have increased bandwidth, improved frequency response, as well as lowered harmonic and intermodulation distortion. Each CMCD incorporated in a packaged loudspeaker system features a Progressive Transition (PT) waveguide providing optimal arrayability, and predictable acoustic performance in real world installations.

Integrated CMCD and PT waveguide systems eliminate typical performance and audible limitations associated with compression/horn loaded midrange systems.

JBL's patent-pending CMCD's are incorporated in packaged loudspeaker systems such as the Application Engineered (AE) Series, and are also available in JBL Professional Custom Shop products to meet unique requirements. Additional systems are always under development. Current information is available at www.jblpro.com, or contact JBL Professional for further details.

© 2002 JBL Professional. All rights reserved.



PROFESSIONAL

JBL Professional
8500 Balboa Boulevard
Northridge, California 91329 U. S. A.

H A Harman International Company

TN Vol 1 No 30
4/02